

A white line-art diagram of an energy storage device. It shows a rectangular box with a lid that is partially open. Inside the box, there is a battery pack with several cylindrical cells and a control unit with various connectors. A thick white line representing a cable loops from the top left, goes over the lid, and then connects to the device inside the box.

# **OPERATION MANUAL FOR ENERGY STORAGE DEVICE**

Moscow, 2021





# OPERATION MANUAL FOR ENERGY STORAGE DEVICE

The company's Quality Management System is certified for compliance with the requirements of ISO 9001



Moscow, 2021

This Operation Manual (hereinafter referred to as the Manual) is intended to familiarize personnel with structure, specifications and operating principle of the energy storage device (hereinafter referred to as the Storage Device) to the extent necessary for operation and checking performance of the Storage Device. The energy storage device is a product which does not require a special training of service personnel, except for a detailed familiarization with this Manual.

# Legend

For safety reasons, paragraphs to pay attention to are indicated in the Manual as follows:



## Strictly prohibited!

«Do not», «Do not allow this», «Do not do this».



## Warning

This is a warning neglect of which can lead to harm to health. It contains a list of unacceptable or necessary actions to reduce the risk of harm to yourself and others.



## Notification

This is a notification on situation that, if ignored, may cause damage to the energy storage device and/or its components. It contains a list of unacceptable or mandatory actions to reduce the risk of damage to the energy storage device and / or its components.

Chapter

**DESCRIP**

**AND OPE**

**TION**

**ERATION**

## Product purpose

The energy storage device is designed to replace standard battery without making changes to the internal electrical circuits of electrical equipment. This manual applies to the following series of energy storage devices:

- LS-LFP12, rated voltage - 12 V
- LS-LFP24, rated voltage - 24 V
- LS-LFP36, rated voltage - 36 V
- LS-LFP48, rated voltage - 48 V
- LS-LFP72, rated voltage - 72 V
- LS-LFP80, rated voltage - 80 V
- LS-LFP96, rated voltage - 96 V
- LS-LFP120, rated voltage - 120 V

Energy storage device capacity of each series can be in the range of 20-1000 Ah.

Designation of the energy storage device:

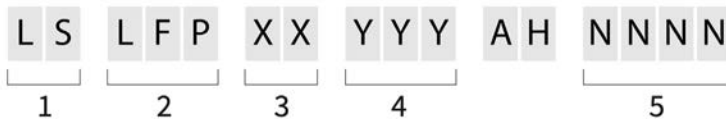

Figure 1. Designation of the energy storage device.

Where:

1. Manufacturer code
2. Energy storage device code indicating type of batteries in the energy storage device
3. Rated voltage on the energy storage device (V)
4. Rated capacity on the energy storage device (Ah)
5. Serial number



The energy storage device is intended for use as a multifunctional device for direct current supply to:

- electric motors of machines and on-board systems of electrified transport;
- other mechanisms, both controlled (loaders, trolleys, etc.) and uncontrolled;

and also suitable for operation:

- in power generation and transmission systems;
- as part of uninterruptible power supplies.

The overall characteristics of the energy storage device correspond to characteristics of the standard battery (Fig. 2), except for special cases due to modification or improvement of the product at the discretion of Manufacturer.

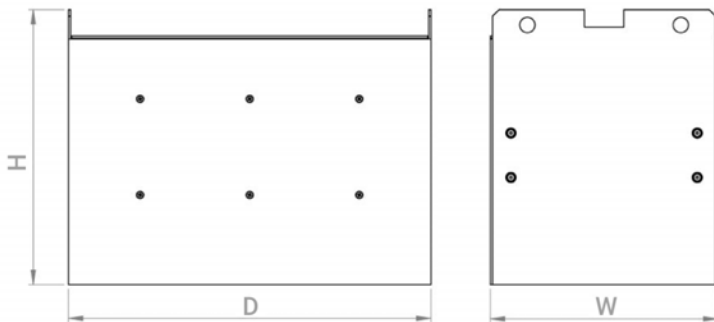

Figure 2. The energy storage device appearance (may differ from the one shown in the figure). D - length, W-width, H-height.

# Specifications

Main specifications of the energy storage device are given in Table 1.

*Table 1. Specifications*

<b>Parameter</b>	<b>Value</b>
Rated voltage (V)	
Rated capacity (Ah)	
Maximum permissible discharge current	
Charger power (kW)	
Charger power supply voltage (V)	
Battery charge time from fully discharged to 85% capacity	100 min, average
Battery charge time from fully discharged to 100% capacity	130 min, average
Type of the energy storage device balancing system	
Type of housing design	

If the requirements set out in this Manual are met, the energy storage device service life is at least 5 years or at least 3,000 charge-discharge cycles with a depth of 80%.

# Product components

The storage device is a functionally complete product consisting of a rechargeable battery based on lithium-ion rechargeable batteries, battery management system (hereinafter referred to as the BMS), switching equipment, and a status indicator (Table 2).

*Table 2. Product complete set*

Name	Value
Lithium - ion rechargeable battery	1
Status indicator:	1
BMS	1
Switching equipment	1

## Description of components

**BMS** monitors status of the energy storage device and performs charge management, balancing and warning of emergency situations during operation. The balancing system being a part of the battery management system can be passive (resistive), active or passive-active type, depending on the series of the energy storage device. The energy storage device appearance is the same for all type of BMS used.

**Status indicator** - a device which displays information about the energy storage device charge level, operating mode, and possible abnormal situations.

**The energy storage device housing** - is a protective shell made of metal or other structural materials and has specified weight and size characteristics.

The energy storage device housing is available in one of three versions:

- standard
- insulated
- heated

In addition to the lithium-ion battery, BMS, and other electrical equipment, a ballast can be placed inside the energy storage device housing to provide a specified mass. On the energy storage device housing, there are mounting places for installation and removal from the equipment.

**Switching equipment** - connectors for connecting to electrical equipment and to the charger (charging device). The connector type and characteristics are determined based on the series of the energy storage device and its operating conditions.

## Design and principle of operation

The energy storage device is a maintenance-free one. Included in the device lithium-ion battery accumulates energy being charged from AC network by means of the charger, and provides the electric vehicle with DC energy during its operation.

On the energy storage device housing, there is a key button for switching on and off the energy storage device (Fig. 3). To switch on the energy storage device, it is necessary to set the button to «I» position, to switch off - to set the button to «0» position.

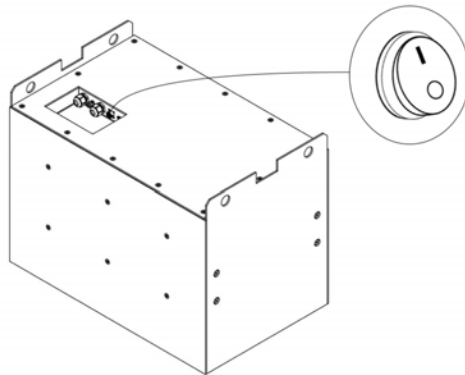

Figure 3. Location of the on / off key button

The energy storage device should be switched off before long-term storage (more than 10 days without switching on), and also before transporting the energy storage device.

The status indicator shown in Figure 4 contains the following elements:

1. Energy storage device level indicator
2. Green LED showing charging process when the charger is connected
3. Red LED indicating abnormal operating states of the energy storage device (low voltage, overcurrent, overheating, etc.)
4. «ON» button to on the indicator
5. «OFF» button to off the indicator

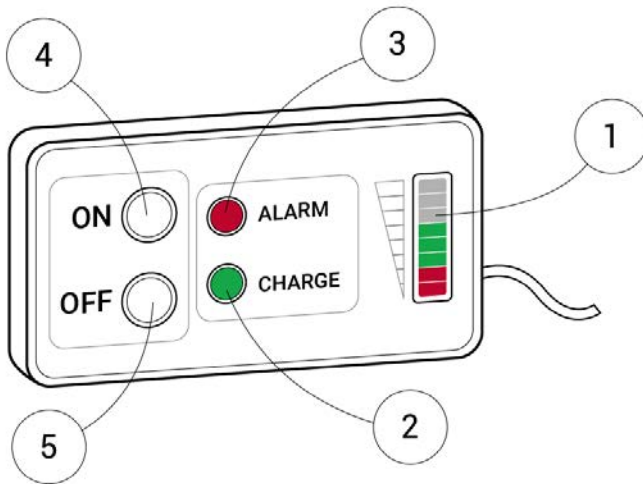
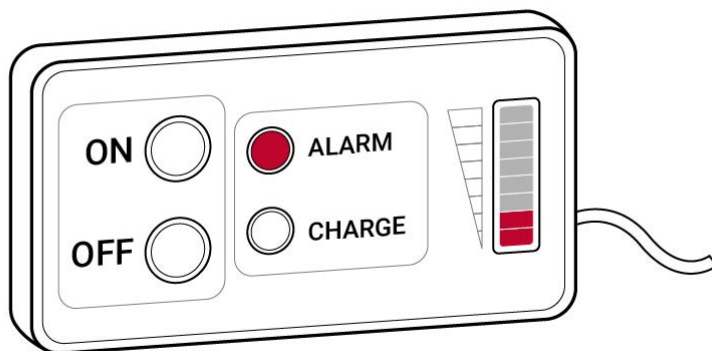

Figure 4. Status indicator of the energy storage device

In case of emergency situations, the energy storage device is switched off, and the status indicator (Fig. 5) receives diagnostic signals together with audible alert of built-in buzzer.



*Figure 5. Emergency display of the energy storage device status*

Diagnostic signals of the indicator are described in Table 3.

Energy storage device light and sound diagnostic signals.

*Table 3. Energy storage device light and sound diagnostic signals.*

<b>Diagnostic signal</b>	<b>Meaning</b>
Continuous signal	Critically low voltage of the batteries included in the lithium-ion battery pack
2 intermittent signals	Overheating of the batteries included in the lithium-ion battery pack
3 intermittent signals	Exceeding the values of charge and discharge currents
5 intermittent signals	Critically low temperature during charging
6 intermittent signals	Failure in the information exchange of the system





Standard electric vehicle indicator may display charge level incorrectly. When determining the charge level, you should focus on readings of the status Indicator which is part of the energy storage device.

The charger is not an integral part of the energy storage device and can be supplied on request. The charger is an AC-to-DC converter which provides charging the energy storage device. The charger type, its parameters (output current, voltage) depend on the parameters of the energy storage device.



The charger has circuits with life-threatening voltage!

## Marking and seal application

A plate which contains information about the main characteristics of the energy storage device is attached to the housing (Fig. 6).

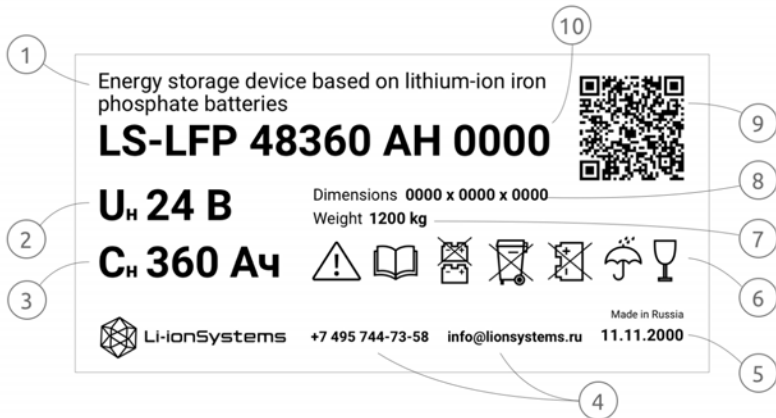









Figure 6. Information plate

1. Name
2. Voltage, V
3. Capacity, Ah
4. Manufacturer's details
5. Manufacture date
6. Handling signs (meaning of the signs is shown in Table 4)
7. Weight, kg
8. Overall dimensions, mm
9. QR code containing a link to the Manufacturer's website
10. Serial number according to the Manufacturer's numbering system

Table 4. Handling signs

Sign	Value
	Attention
	Read Operation Manual;
	No stacking
	Special disposal
	Not to turn over
	Protect against moisture
	Caution Fragile



Removing and applying the seal to the energy storage device is strictly prohibited.

An energy storage device with a damaged or removed protective seal (located at the cover attachment points) is not covered by the warranty.

A large, dark gray number '2' is positioned on the left side of the page, serving as a background element for the chapter title.

Chapter

**INTENDED**

USE

# Operating temperature range

Table 5. Operating temperature range

Elevated environment temperature	Maximum operation value, °C	plus 40
	Maximum value at transportation, °C	
	Maximum value at storage, °C	
Lowered environment temperature	Minimum operation value, °C	minus 10 minus 25 minus 35
	Standard	
	Insulated	
	Heated	
	Minimum value at transportation, °C	minus 35
	Standard	
Insulated		
Heated		
Minimum value at storage, °C	0 0 0*	
Standard		
Insulated		
Heated		

\* The energy storage device of heated version can be stored in sub-zero temperatures with a charger connected to the energy storage device from which continuous heating is carried out.

In the case of long-time (more than 10 days without switching on) downtime of equipment, as a result of which the energy storage device cools below -10 °C, it is necessary to warm up the energy storage device to a temperature of 0 °C or higher before charging.



It is forbidden to open the housing of the energy storage device, charger, indicator, to make changes to design and configuration (including changing the cable plugs, increasing the cable length, etc.). Do not allow water and conductive dust to accumulate on the energy storage device and to enter inside it.

## Preparing the product for use



Due to the risk of condensation, it is necessary to maintain the energy storage device for at least 6 hours in an environment with the temperature at which the energy storage device will be operated (during transition from a cold to a warm room) before starting operation.



Before using the energy storage device, make sure that insulation of power cables and the main wire is intact.



### PLEASE NOTE

One type of Class D, carbon dioxide, powder, foam, or inert gas fire extinguisher shall be provided near the area where the lithium-ion energy storage units are used.

Energy storage device preparation for use consists in installing it on an electric vehicle in the place intended for standard lead-acid traction battery and connecting the energy storage device to the power circuit of the electric vehicle.

To lift the energy storage device use eyelets on the walls of the energy storage device housing or eye bolts according to the housing design.

All installation and transport work should be carried out using equipment with a load capacity not less than the energy storage device weight (loader, crane-beam, etc.). The sling angle of deviation from the vertical should not exceed 30°.

After the energy storage device is installed, make sure that the on/off key button (Fig. 3) on the energy storage device housing is set to «I» position (on). Otherwise, power connector of the energy storage device will be de-energized.



After the energy storage device is installed, fully charge it (see Section «Charging the energy storage device»). Make sure that at the end of the cycle, the status indicator shows charge of at least 90%.

After charging, disconnect the energy storage device from the charger and connect to the vehicle power connector. Place the status indicator (Fig. 7) of the energy storage device in a place convenient for driver, push «ON» button. If there are no errors, the energy storage device will turn on and the battery level will be displayed (1). Otherwise, power connector of the energy storage device will be de-energized.



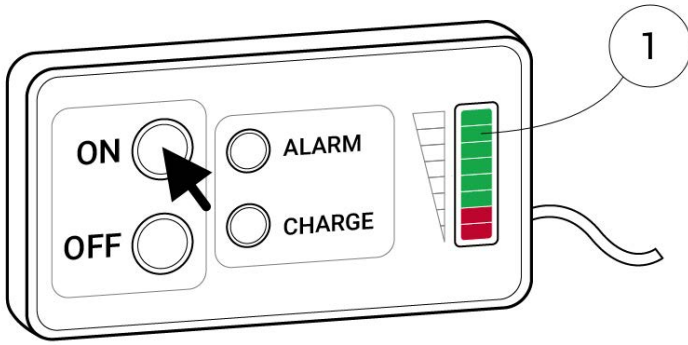

Figure 7. Turning on energy storage device.

## Product use

The following must be observed when working with the Energy storage:

- Only personnel who have studied this operating manual should work with the Energy storage.
- Do not expose the Energy storage to naked flames or heat sources with temperatures of 60 °C or more. Doing so may cause the Energy storage to overheat or catch fire, and may also affect its performance and shorten its service life.
- Improper use may cause the Energy storage to overheat or cause serious injury to personnel.

Observe the following safety rules:

- Do not allow a short circuit between the Energy storage terminals.
- Observe the polarity.
- Do not open the Energy storage.
- Do not subject the Energy storage to excessive mechanical abuse.
- The humidity when using the Energy storage should not exceed 95%.
- The forklift operator must operate the forklift carefully to avoid puncturing or damaging the battery.
- If you notice any unusual odor, Energy storage deformation or other abnormal signs during operation, stop operation immediately, disconnect the Energy storage from the loader or charger, and contact Technical Support.



In the event of an accident (impact, overturning or collision of the loader), there is a risk of damage, puncturing or deformation of the Energy storage.

If the Energy storage is damaged, set up a safe area around it of at least 5 m.



Technical support service:  
written inquiries by e-mail [support@lionsystems.ru](mailto:support@lionsystems.ru)  
(24 hours a day),

technical support service by tel.

+7 (495) 744-73-58, add 2 or

+7 (927) 109-96-44 (from 8:00 to 17:00 Moscow  
time),

leave a message for technical support by tel.

+7 (495) 744-73-58 (from 17:00 to 8:00 Moscow  
time).

Electric vehicle powered from the energy storage device is operated in the same way as when using a standard lead-acid battery, in accordance with the Operation Manual for the electric vehicle.

The energy storage device charge level can be estimated using a scale located on the energy storage device status indicator (Fig. 8).

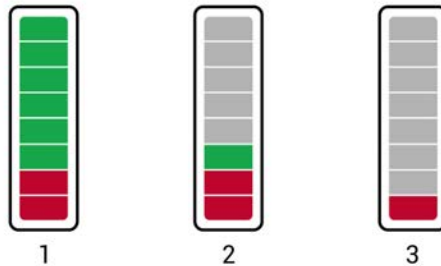

Figure 8. Scale of charge level of the energy storage device

#### Meaning of charge level

1. Energy storage device is charged
2. Charging is required
3. Critical charge level

When the voltage level is low, red LED on the status indicator flashes and periodic buzzer sound is heard. At high load on the energy storage device (for example, simultaneous operation of hydraulic drive and electric stroke drive, etc.), a short low voltage signal may be actuated even before full discharge. At that, working can be continued without the risk of excessive discharge.



When the energy storage device is constantly running in incomplete charge state, charge level reading of the status indicator will gradually accumulate an error, and to eliminate the error it is necessary to fully charge the energy storage device at least once every two weeks until green LED of the status indicator stops flashing, regardless of what level of charge is displayed on the scale. Continuous glow of the energy storage device status indicator indicates completion of a full charging cycle

Continuous operation of the low voltage indicator (red LED flashing and buzzer sound) in a stationary state or at a low intensity of operation indicates the need for urgent charging of the energy storage device, even if the scale shows a high charge level.



If the energy storage device voltage drops below permissible level, the BMS will automatically de-energize the power connector of the energy storage device. At that, all electric vehicle circuits will be de-energized. If this situation occurs, it is necessary to immediately move the electric vehicle to the charger and to charge it. If it is impossible to move under own power, it is necessary to tow the electric vehicle to the charger using any possible mean.

To fully realize advantages of the energy storage device, you should use breaks in the equipment operation for recharging. Partial charging does not negatively affect service life of the energy storage device, provided that it is periodically fully charged (at least once every two weeks).



It is forbidden to keep the energy storage device with a low charge level (less than 20%) for more than 6 hours, because due to own BMS consumption, a critically strong discharge of the energy storage device can occur, and its charging from the charger in the usual way will become impossible.

# Connecting the charger to AC power grid

The following requirements apply to the charging device location:

1. The charger should be located on a flat, stable surface.
2. Free air access to the inlet and outlet ventilation grilles of the charging device should be provided.
3. It is necessary to exclude ingress of water on the surface and inside the charger.
4. The premise should be free of conductive dust (for example, coal, metal, cement, paper, cotton, etc.).
5. Ambient temperature should be between 0 °C and +40 °C.

Regarding to the rest, it is necessary to adhere to the requirements of the Electrical Installation Regulations (PUE), Fire safety requirements for territories, buildings, structures and premises. According to the statement of the FSUE VNIPO EMERCOM of Russia, placement and operation (including charging) of the energy storage devices directly in production and storage rooms (**without equipping specialized charging rooms**) , when requirements of Operation Manual are followed, are allowed and do not change their categories according to SP 12.13130.2009.

## Charging the energy storage device

The Storage Device should be charged without removing it from the electric vehicle. After transporting the energy storage device and installing it on the electric vehicle, the first charging process should be monitored to make sure that the automatic charger system is working properly. Further, charging is carried out in fully automatic mode and does not require personnel involvement or control by personnel.

When charging the energy storage device, green LED on the status indicator shows the following modes (Fig. 9)

- Green LED blinks - the main charging stage (1);
- The green LED glows - the energy storage device is charged (2).

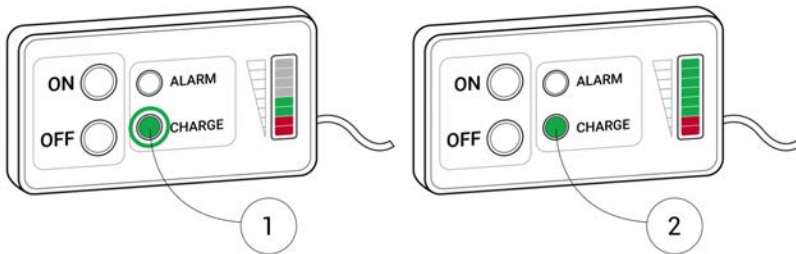

Figure 9. Displaying charging modes

To charge the energy storage device, the electric vehicle should be completely stopped, to avoid accidental movement, turn off the ignition key, and take other measures to prevent spontaneous movement of electric vehicles.



To turn off the battery, push «OFF» button on the indicator. Connect the SWITCHED-OFF battery to the SWITCHED-ON charger using the power connectors, push «ON» button on the indicator to turn on the battery. «CHARGE» signal on the indicator will start flashing, and the charger display will count down to the start of charging. The key button on the energy storage device housing should be in «I» position. Otherwise, charging the energy storage device is impossible.

#### ATTENTION!

1. If the battery has two REMA connectors, the charger connector is used to connect, while the connector to the equipment remains connected.
2. The energy storage device of heated version can be stored in sub-zero temperatures with a charger connected to the battery from which continuous heating is carried out.

The fixed charger connector should be connected to the energy storage device connector (Fig. 10).

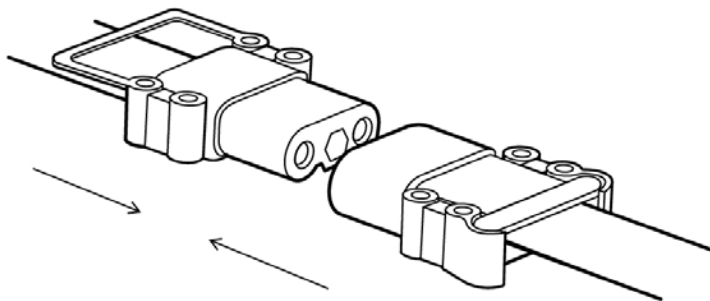

Figure 10. Connecting the charging connectors

During the charging stage, it is possible to switch off the charger during the balancing stages. At that, the messages 18, 31, No Bat may be displayed on the charger, while the energy storage device does not need to be disconnected from the charger, charging process will continue after 3 minutes.



A sign of the end of charging process is continuous glow of the green LED on the status indicator of the energy storage device (Fig. 9).

Since the energy storage device does not have a «memory effect», the energy storage device can be charged at any time, regardless of current charge level. It is allowed to recharge without waiting for the energy storage device to be fully charged.

It is recommended to charge the energy storage device at least once every two weeks until the end of charging (green LED on the status indicator of the energy storage device is continuously glowing).



It is forbidden to connect the energy storage device to a charger designed for lead-acid batteries and having voltage and power connector which does not match to the energy storage device! This can lead to malfunction of the energy storage device components and charger for lead-acid batteries.

Electric vehicle operation can be resumed after both full and partial charging of the energy storage device. To stop charging and start working, it is necessary to:

1. Turn off the charger according to Operation Manual for corresponding charger.
2. At the end of the charging stage, «CHARGE» indicator will glow continuously, then disconnect the charging connector of the charger from the energy storage device (Fig. 11).

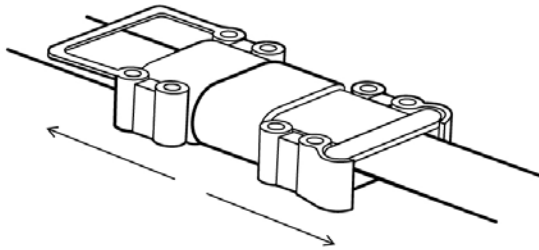

*Figure 11. Disconnecting the charging connectors*

## Emergency response

The Energy storages do not present a chemical hazard under normal use. For example, the Energy storages must not be opened or exposed to fire.

At abnormal condition of the energy storage device, the main danger is the possibility of electric shock due to damage to electrical insulation, and also intensive release of stored energy from the energy storage device in the case of a short circuit caused either by faulty switching or mechanical damage to the batteries that are part of the lithium-ion rechargeable battery, due to impact or deformation.

In the case of suspected damage to the insulation or occurrence of a short circuit, the electric vehicle operation should be stopped immediately and possible measures should be taken to protect personnel against electric shock, burns. Call a representative of the manufacturer to inspect the energy storage device and identify the cause of the accident.

The contents of an opened Energy storage (batteries) can cause irritation and allergic reactions.

#### **When in contact with the eyes**

- Rinse with water.
- Visit a doctor.

#### **In contact with the skin**

- Remove any clothing on which you have spilled the contents of the Energy storage.
- Rinse your skin with soap and water.
- Visit a doctor.

#### **When inhaling**

- Place the injured person in the open air.
- Visit a doctor.

### **WARNING**

If the battery is damaged, handle the open Energy storage in a well-ventilated area with the following safety precautions in place:

*Table 6. Safety precautions*

Respiratory protection	Mask equipped with ABEK filters or self-contained breathing apparatus. The mask, also called a lifesaver, must cover the face completely.
Hand protection	Protective gloves made of propylene, polyethylene.
Eye protection	Protective goggles with side flaps or face covering mask
Other	A suit that protects against skin contact with the contents of the element.

# Maintenance



Improper handling of the electrical circuits and devices inside the energy storage device can lead to its failure, and to electric shock!

During normal operation, the energy storage device does not require specific maintenance. In the case of the energy storage device malfunctions, maintenance work should only be performed by qualified personnel directed by the energy storage device Manufacturer or authorized service center. In the event of external malfunctions: damage to power connectors and cables, maintenance work may be carried out by personnel directly servicing the equipment, and safety measures should be taken to prevent electric shock to personnel, to prevent a short circuit of the energy storage device.

At least once every 6 months, personnel directly servicing the equipment should perform a visual check of the power cable insulation integrity of the charger and energy storage device.

## **PLEASE NOTE**

Do not wash the Energy storage with water. Disconnect the Energy storage before you clean it. To remove dirt, use compressed air to blow it off or a vacuum cleaner to collect the dust.

## Storage

Before transferring to storage, it is recommended to bring the charge level of the energy storage device to 80%, then push «OFF» button on the energy storage device status indicator, the key button on the energy storage device housing should be moved to «0» position.

Avoid long-term storage of the energy storage device at a charge level of 50% or lower.

The energy storage device, regardless of whether it is installed on an electric vehicle or not, should be stored in upright position, partially charged, in heated storage at a temperature from 0 °C to plus 40 °C and at relative humidity not more than 80%. The energy storage device of heated version can be stored in sub-zero temperatures with a charger connected to the energy storage device from which continuous heating is carried out.

During long-term storage (more than 10 days without switching on), connect the energy storage device to the charger to recharge for 20-30 minutes at least once every three months.

It is strongly recommended that you fully charge the Energy storage every three months to avoid performance degradation.

If the energy storage device is stored for more than two months, the status indicator readings will be unreliable due to gradual self-discharge of the energy storage device. In this case, before using the energy storage device, it is necessary to fully charge it until continuous green LED glow on the status indicator.

**PLEASE NOTE**

The battery with a very low charge level (deep discharge) cannot be recharged. Contact Technical Support immediately (see section Product Use).

- It is highly recommended to store the Energy storage on pallets. Do not lift the batteries too high (above 100 cm) to reduce the risk of them falling when you move them.
- Do not store the Energy storages on the ground to prevent moisture penetration or external exposure.



# Transportation

Before transporting the Energy storage, you must familiarize yourself with the current regulations on the transport of goods by automobile transport. When preparing to pack and transport the Energy storage, strictly follow these rules.

Before transportation, the key button on the energy storage device housing should be moved to «0» position. The energy storage device should be transported in the upright position on a pallet being securely attached by straps, shrink wrap or other material which prevent displacement during transportation, including displacement relative to pallets, by any type of closed transport which ensures protection against atmospheric precipitation during transportation, at any distance, at an ambient temperature from minus 35 °C to plus 40 °C and relative humidity of up to 80%, without condensation.

It is allowed to transport the storage device inside an electric vehicle.

The energy storage device should not be dropped or hit during transport, storage, or operation.

## Disposal

Make sure the battery is discharged before sending it for disposal. For disposal, contact the manufacturer (see chapter Product Use).



The batteries included in the lithium-ion battery pack should only be disposed by specialized companies. It is forbidden to dispose of the energy storage device in places for disposal of general or household waste. In case of accidental destruction of lithium-ion batteries, the Manufacturer of the energy storage device should be notified immediately.

# Acceptance Certificate

A device, serial number: \_\_\_\_\_, complies with requirements of TU 3482-001-18715490-2014, technical documentation and is recognized as serviceable.

Quality Service Representative

\_\_\_\_\_/\_\_\_\_\_  
(Signature) (full name)

QCD stamp:

# Troubleshooting

Table 7. Possible cause of the fault and its remedy

Fault	Cause	Remedy
<p>Voltage on the power connector of the energy storage device is zero.</p>	<p>"ON" button on the energy storage device status indicator is not pushed, or the key button on the energy storage device housing is set to "0", or the status indicator is not connected to the energy storage device.</p>	<p>Connect the status Indicator to the energy storage device. Turn on "ON" button on the status indicator. Move the key button on the energy storage device housing to "I" position.</p>
<p>Voltage on the energy storage device is zero although the status indicator is connected to the energy storage device, the key button on the energy storage device housing is switched on.</p>	<p>The energy storage device is excessively discharged, or connection between the status indicator and BMS is broken.</p>	<p>Call the Manufacturer's representative to eliminate the problem.</p>

<p>When the energy storage device charge level is high during transport operation, a low-voltage LED and audible alarm will be activated on the status indicator.</p>	<p>The actual charge level of the energy storage device does not correspond to the status indicator readings.</p>	<p>Fully charge the energy storage device (green LED on the status indicator glows continuously).</p>
	<p>Voltage drawdown due to high load on the energy storage device.</p>	<p>Divide in time the stroke engine and hydraulic pump work. Move the power control of the electric vehicle motor to a lower position (if available).</p>
<p>Red LED on the energy storage device status indicator is always on and audible alarm is activated.</p>	<p>Critically low battery level of the energy storage device.</p>	<p>Immediately connect the energy storage device to the charger and charge it. To prevent further discharge of the energy storage device, if possible, do not move the electric vehicle to the charger on its own. Use a tug, or bring the charger to the vehicle.</p>

	<p>BMS error.</p>	<p>Turn off the status indicator by pressing "OFF" button, disconnect the status indicator from the energy storage device, and call the Manufacturer's representative to eliminate the problem.</p>
--	-------------------	---

Li-ION Systems, LLC  
Tel: +7 (495) 744-73-58  
E-mail: [info@lionsystems.ru](mailto:info@lionsystems.ru)  
[lionsystems.ru](http://lionsystems.ru)

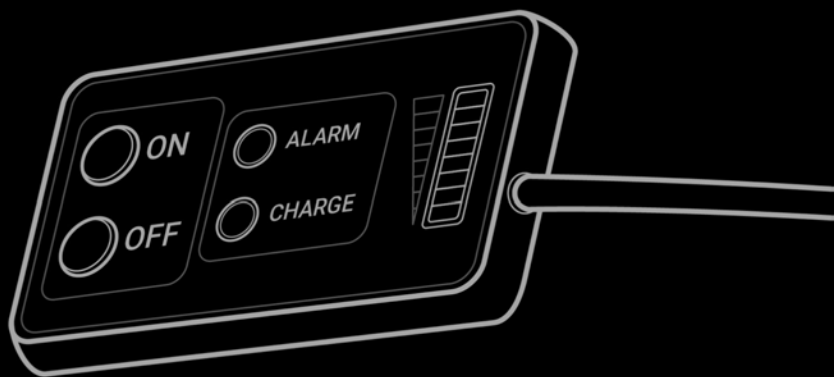

Li-ionSystems

[lionsystems.ru](http://lionsystems.ru)